

MBF Series

Hand Pallet Truck • 2.5 tonnes

MBF25(W)M
MBF25(W)H
MBF25(W)J
MBF25(W)I

Low-cost pallet truck... High quality construction

Top quality doesn't need to come at a high price. Our low-cost hand pallet trucks give you everything you need to do the job – plus a whole lot more. Built to the standards you'd expect from a world-leading manufacturer, these hard-wearing trucks are engineered for maximum strength and durability. Low-maintenance features, such as the quick-fit steer wheel and self-lubricating components, reduce downtime. And, like every truck bearing the Mitsubishi Forklift Trucks

name, every hand pallet truck is supplied with the full parts backup you need to keep your truck (and your business) in action for the long-term.

Like every Mitsubishi model, our hand pallet trucks are fully customisable. A wide range fork dimensions and specialist wheels – including tandem load and steer wheels – are available to suit your application. In addition, these rugged models can be fitted with brakes for an added level of safety.

Frame and body

- **Strong chassis** gives operator confidence in any application.
- **Steel entry brackets** offer exceptional durability in all working conditions.
- **Low centre of gravity** adds further stability, for safer operation.
- **Compact design** combined with a 210-degree steering angle gives maximum manoeuvrability.



MBF Series

Hand Pallet Truck • 2.5 tonnes

Characteristics						
1.1	Manufacturer (abbreviation)		Mitsubishi	Mitsubishi	Mitsubishi	Mitsubishi
1.2	Manufacturer's model designation		MBF25(W)M	MBF25(W)H	MBF25(W)J	MBF25(W)I
1.4	Operator type		Pedestrian	Pedestrian	Pedestrian	Pedestrian
1.5	Load capacity	Q kg	2500	2500	2500	2500
1.6	At load centre	c (mm)	600	600	600	600
1.8	Load distance	x (mm)	883	883	953	733
1.9	Wheelbase	y (mm)	1190	1190	1260	1040
Weights						
2.1	Truck weight with nominal weight	kg	65	70	80	60
Wheels, chassis						
3.1	Tyres (P= polyurethane, N=Nylon, R=Rubber)		P,N,R	P,N,R	P,N,R	P
3.2	Tyre dimension (steering side)	∅ (mm)	200	200	200	200
3.3	Tyre dimension (load side)	∅ (mm)	80	80	80	80
3.5	Number of wheels steering/loadside single/tandem		1/2×1 - 1/2×2	1/2×1 - 1/2×2	1/2×1 - 1/2×2	1/2×1 - 1/2×3
3.6	Track width (steering side)	b10 (mm)	109	109	109	109
3.7	Track width (load side)	b11 (mm)	370	370	370	370
Dimensions						
4.4	Fork height fully lowered	h13 (mm)	85	85	85	85
4.9	Overall length	l1 (mm)	1533	1533	1603	1383
4.14	Length to fork face	l2 (mm)	384	384	384	384
4.15*	Overall width	b1/b2 (mm)	520	685	685	685
4.19*	Fork dimensions (thickness, width and length)	s,e,l (mm)	45 / 160 / 1150	45 / 160 / 1150	45 / 160 / 1220	45 / 160 / 1000
4.20*	Outside width over forks (minimum / maximum)	b5 (mm)	520	685	685	685
4.21	Ground clearance at centre of wheelbase (forks lowered)	m2 (mm)	40	40	40	40
4.22	Working aisle width (Ast3) with 1000 × 1200 pallets, load crosswise	Ast (mm)	1516	1516	1517	1516
4.25	Working aisle width (Ast3) with 800 × 1200 pallets, load lengthwise	Ast (mm)	1716	1716	1717	1716
4.32	Turning circle radius	Wa (mm)	1266	1266	1336	1166
4.33	Lift height	h3 (mm)	115	115	115	115
4.34	Height of Tiller Arm /Steering console (min./max.)	h14 (mm)	1224	1224	1224	1224

* See table below

Model	Fork dimensions W x L (mm)		Load wheels	Steering wheel
MBF25(W)MNSN	520 × 1150	2	Single, Nylon	Nylon
MBF25(W)MNTN	520 × 1150	4	Tandem, Nylon	Nylon
MBF25(W)MPSP	520 × 1150	2	Single, Polyurethane	Polyurethane
MBF25(W)MPTP	520 × 1150	4	Tandem, Polyurethane	Polyurethane
MBF25(W)HNSN	685 × 1150	2	Single, Nylon	Nylon
MBF25(W)HPSP	685 × 1150	2	Single, Polyurethane	Polyurethane
MBF25(W)HPTP	685 × 1150	4	Tandem, Polyurethane	Polyurethane
MBF25(W)JNSN	685 × 1220	2	Single, Nylon	Nylon
MBF25(W)JNTN	685 × 1220	4	Tandem, Nylon	Nylon
MBF25(W)JPSP	685 × 1220	2	Single, Polyurethane	Polyurethane
MBF25(W)JPTP	685 × 1220	4	Tandem, Polyurethane	Polyurethane
MBF25(W)IPTP	685 × 1000	4	Tandem, Polyurethane	Polyurethane
MBF25(W)MRSN	520 × 1150	2	Single, Nylon	Rubber
MBF25(W)MRTN	520 × 1150	4	Tandem, Nylon	Rubber
MBF25(W)MRSP	520 × 1150	2	Single, Polyurethane	Rubber
MBF25(W)MRTP	520 × 1150	4	Tandem, Polyurethane	Rubber



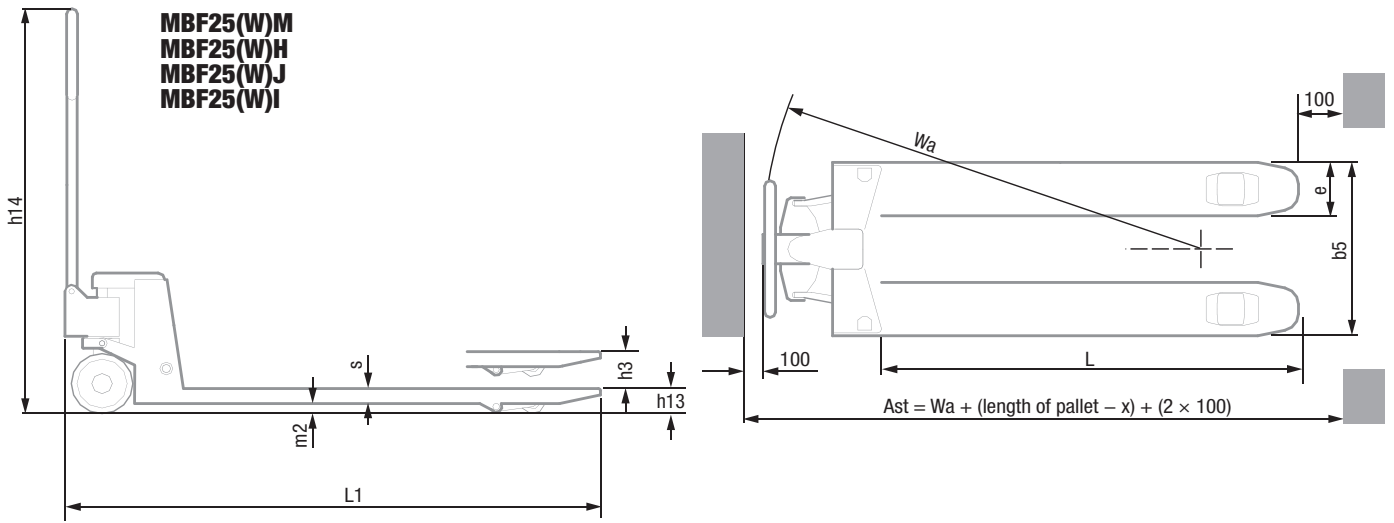



Controlled lowering valve



Smooth wheels



Optional Load Weight Indicator (W)

Forks

- **Mounted rollers on fork tips** allow effortless entry and exit to and from pallets.

Hydraulics

- **Overload bypass valve** minimises damage from excess weight for long truck life.
- **Lowering valve** restricts the rate of descent, to prevent load damage.
- **Reliable leak-proof hydraulic system** reduces need for unplanned maintenance.
- **Adjustable pump cap** ensures a long service life.

Operator environment and controls

- **Ergonomic rubber handle** offers comfort, safety and high productivity.
- **Three-position lever** automatically returns to a neutral setting when not in use, to reduce operator fatigue.
- **Low ground clearance** (just 40mm) minimises risk of foot trapping.

Other features

- **Well-placed lubrication points** on all movable parts allow for easy maintenance and a long truck life.
- **Easy-fit steering wheel** allows for quick replacement.
- **Effortless lift action** requires just 10 strokes to reach full height.

Options

- **Ergonomic nylon and Polyurethane steering wheel**
- **Tandem load wheels**
- **Choice of drive and load wheels for different applications**
- **Wide variety of fork dimensions**
- **Load Weight Indicator**

when **reliability** is **everything...**

Like any product bearing the Mitsubishi name, our materials handling equipment benefits from the huge resources and cutting-edge technology of one of the world's largest corporations. So when we promise you **quality, reliability** and **value for money**, you know it's a guarantee we have the power to deliver.

Every model in our comprehensive, award-winning range of forklift trucks and warehouse equipment is built to a high specification and is designed to keep on working for you... day after day... year after year... whatever the job... whatever the conditions.

To ensure your truck stays in constant productive action, we have a network of local dealers – hand-picked for their commitment to customer care... and backed up by the Mitsubishi Forklift Trucks organisation. No matter where you are, we have a dealer close by – ready and willing to meet your needs.

That friendly local service covers everything from identifying the perfect model and configuration for your application to providing competitive, flexible finance and maintenance packages, unbeatable warranties, long and short term hire, and highly responsive field service and repairs... as well as the industry's quickest and most reliable parts supply.

Only Mitsubishi can give you this combination of global engineering excellence and outstanding local support... only Mitsubishi offers you such a quality product at such an affordable price... and only Mitsubishi places reliability as high as you do in its priorities. Contact your local dealer now and see what Mitsubishi can do for you.

You can find your nearest dealer at www.mitforklift.com



MBF25



WEGM1700 (02/15)
© 2015 MCFE
Printed in The Netherlands

mitforklift@mcf.nl www.mitforklift.com

NOTE: Performance specifications may vary depending on standard manufacturing tolerances, vehicle condition, types of tyres, floor or surface conditions, applications or operating environment. Trucks may be shown with non-standard options. Specific performance requirements and locally available configurations should be discussed with your distributor of Mitsubishi forklift trucks. Mitsubishi follows a policy of continual product improvement. For this reason, some materials, options and specifications could change without notice.